

Pannello in agglomerato di particelle di legno spessore 22 mm in finitura melaminica nelle tonalità previste, bordato in ABS spessore 1 mm, finito con raggio 1 mm. L'incollaggio dei bordi è effettuato con colle poliuretatiche termofondenti, resistenti all'umidità ed alla temperatura.

Holzspanplatte Stärke 22 mm, mit Melaminbeschichtung in den angebotenen Farben, ABS-Kante der Stärke 1 mm mit 1 mm Radius. Die Kanten werden mit Polyurethan-Schmelzkleben aufgeleimt, die feuchtigkeits und temperaturbeständig sind.

GRUPPO PREZZI / PREISGRUPPE

1

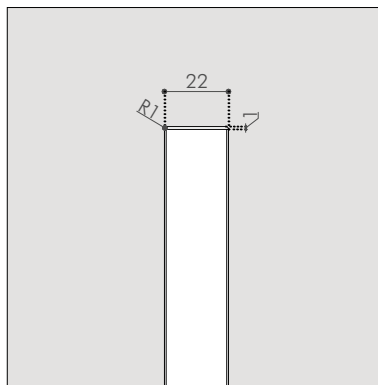
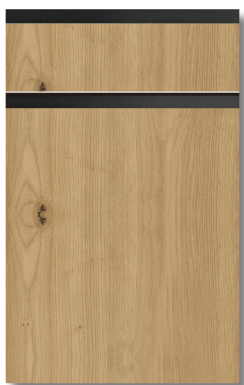

COLORI FRONTALI TINTA UNITA

EINFARBIGE FRONTFARBEN

05 grigio orione



13 bianco



14 grigio luce

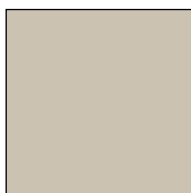

15 taupe scuro

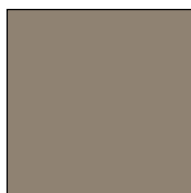

COLORI FRONTALI EFFETTO LEGNO

FRONTFARBEN HOLZEFFEKT

56V larice
termotrattato

58V larice bruno

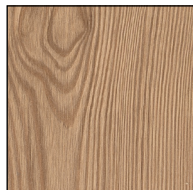

59V larice antracite



60V larice bianco

62V rovere
halifax naturale63V rovere
halifax tabacco81V rovere nodi
naturale

82V olmo bruno

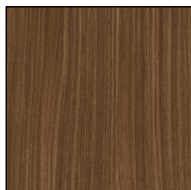

83V noce lincoln

ISO
22196

Tutti i pannelli nobilitati sono caratterizzati da elevate proprietà antibatteriche ottenute grazie alla superficie a base di resina melaminica, senza l'aggiunta di additivi (test conformi alla ISO 22196). E' sufficiente una pulizia domestica regolare per mantenere tali proprietà invariate.

Alle melaminbeschichteten Platten zeichnen sich durch hohe antibakterielle Eigenschaften aus, die dank der Oberfläche auf Melaminharzbasis ohne Zusatz von Zusatzstoffen erzielt werden (Prüfungen nach ISO 22196). Regelmäßige Haushaltsreinigung reicht aus, um diese Eigenschaften unverändert zu erhalten.

Colori speciali a richiesta con sovrapprezzo
Consegna 5 settimane

Sonderfarben auf Anfrage mit Aufpreis
Lieferzeit 5 Wochen



FUTURA B

LAMINATO HPL MATERICO
LAMINAT HPL

Pannello in agglomerato di particelle di legno spessore 22 mm, placcato fronte e retro in laminato HPL, bordato in ABS spessore 1,5 mm, finito con raggio 1,5 mm. L'incollaggio dei bordi è effettuato con colle poliuretaniche termofondenti, resistenti all'umidità ed alla temperatura.

Holzspanplatte Stärke 22 mm, Vorder- und Rückseite mit HPL-Laminat beschichtet, 1,5 mm ABS-Kante mit 1,5 mm Radius. Die Kanten werden mit Polyurethan-Schmelzklebern aufgeleimt, die feuchtigkeits und temperaturbeständig sind.

GRUPPO PREZZI / PREISGRUPPE

2

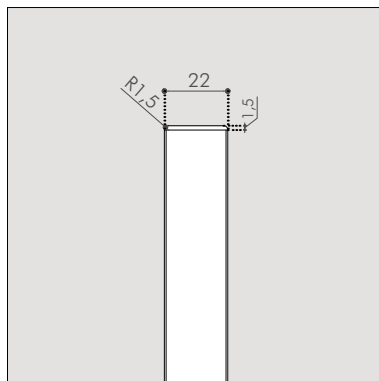
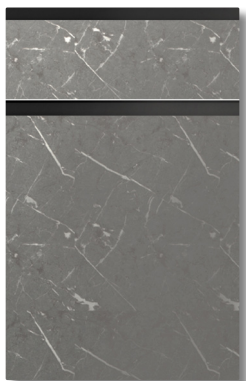

COLORI FRONTALI CEMENTO

CEMENTO GESÄGTE FRONTFARBEN

930 zement



931 cimant white



932 cimant ash

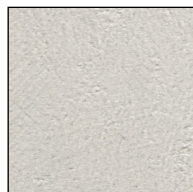

933 cimant grey



COLORI FRONTALI PIETRA

PORPHYR GESÄGTE FRONTFARBEN

964 pietra luna



965 pietra nera



966 pietra bianca



COLORI FRONTALI METALLO

PORPHYR GESÄGTE FRONTFARBEN

934 bronze



935 silver



COLORI FRONTALI MARMO

MÄRKEL GESÄGTE FRONTFARBEN

920 marmo statuario

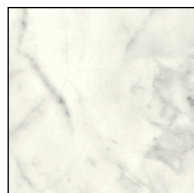

921 marmo alicante

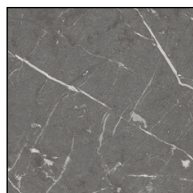

922 marmo marquinia

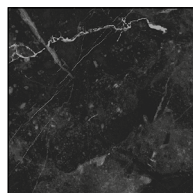
ISO
22196

Tutti gli HPL materici sono caratterizzati da uno strato decorativo antibatterico che, unitamente all'impiego delle corrette pratiche di pulizia, è in grado di ridurre la carica batterica fino al 99,9% (test conformi alla ISO 22196).

Alle HPL-Materialien sind in Laminat Ausführung, sie zeichnen sich durch eine dekorative antibakterielle Schicht aus, die zusammen mit der Anwendung der richtigen Reinigungspraktiken in der Lage ist, die Bakterienbelastung auf 99,9% zu reduzieren (Tests nach ISO 22196).

Colori speciali a richiesta con sovrapprezzo
Consegna 5 settimane

Sonderfarben auf Anfrage mit Aufpreis
Lieferzeit 5 Wochen



FUTURA B**LAMINATO HPL TINTE UNITE**
LAMINAT HPL FARBTÖNE

Pannello in agglomerato di particelle di legno spessore 22 mm, placcato fronte e retro in laminato HPL, bordato in ABS spessore 1 mm, finito con raggio 1 mm. L'incollaggio dei bordi è effettuato con colle poliuretaniche termofondenti, resistenti all'umidità ed alla temperatura.

Holzspanplatte Stärke 22mm, Vorder- und Rückseite mit HPL-Laminat beschichtet, 1 mm ABS-Kante mit 1 mm Radius. Die Kanten werden mit Polyurethan-Schmelzklebern aufgeleimt, die feuchtigkeits und temperaturbeständig sind.

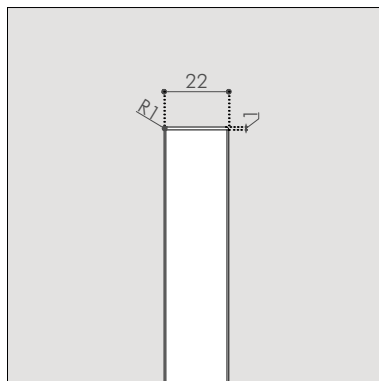
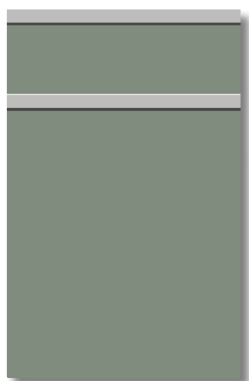
GRUPPO PREZZI / PREISGRUPPE**2****COLORI FRONTALI CEMENTO***ZEMENT GESÄGTE FRONTFARBEN*

A410 bianco ghiaccio



A831 rosso mattone



A1940 india

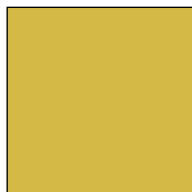

A1941 cadaques



A1942 tuareg

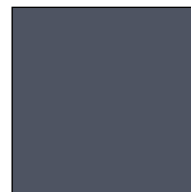

A1943 tenebre



A1944 squalo

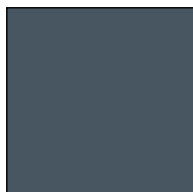

A1945 gange

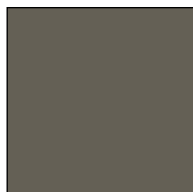

A1946 orage

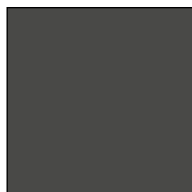

A1947 agave



Colori speciali a richiesta con sovrapprezzo
Consegna 5 settimane

*Sonderfarben auf Anfrage mit Aufpreis
Lieferzeit 5 Wochen*



LACCATO MONOFACCIALE
EINSEITIG LACKIERT

Pannello in MDF spessore 22 mm, con lato anteriore in finitura laccata supermatt, ottenuta mediante un elaborato trattamento di indurimento UV delle vernici. Rivestimento melaminico in tinta sul lato retro, bordato in ABS spessore 1 mm, finito con raggio 1 mm. L'incollaggio dei bordi è effettuato con colle poliuretaniche termofondenti, resistenti all'umidità ed alla temperatura.

MDF-Platte 22 mm stark, mit Vorderseite in supermatter Lackierung, erhalten durch eine aufwendige UV-Härtung der Lacke. Melaminbeschichtung in passender Farbe auf der Rückseite, eingefasst in ABS 1 mm dick, mit 1 mm Radius ausgeführt. Die Kanten werden mit thermoschmelzenden, feuchtigkeits- und temperaturbeständigen Polyurethanklebern verklebt.

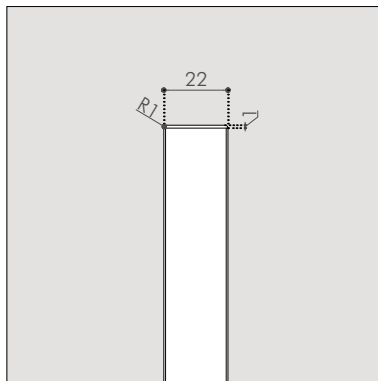
GRUPPO PREZZI / PREISGRUPPE**2****COLORI FRONTALI SUPERMATT**
SUPERMATTE FRONTFARBEN

130 bianco supermatt

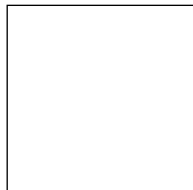

131 sahara supermatt



132 grigio seta supermatt



133 antracite supermatt



134 nero supermatt

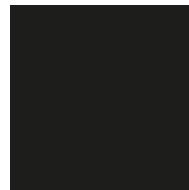

BALI A

LACCATO OPACO
MATT LACKIERT

Pannello in MDF spessore 22 mm, bordato in ABS spessore 1,5 mm, spigoli con raggio 1,5 mm.
Laccatura ecologica opaca a base acqua.

*MDF-Platte Stärke 22 mm, eingefasst in ABS Stärke 1,5 mm, Kanten mit 1,5 mm Radius.
Umweltfreundliche Umweltschonende matte Lackierung auf Wasserbasis.*

GRUPPO PREZZI / PREISGRUPPE

3



Maniglia OLS
Griff OLS



Maniglie PVL e PV24
Griffen PVL und PV24

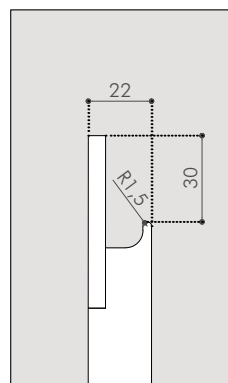
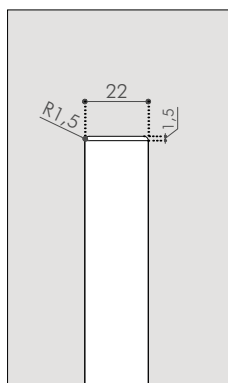

Maniglia PVL
Griff PVL

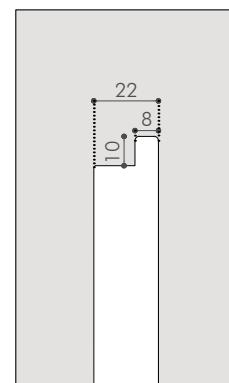

Maniglia LV
Griff LV

COLORI FRONTALI finitura opaca
FRONTFARBEN matt Ausführung

501-0 argilla



502-0 avorio

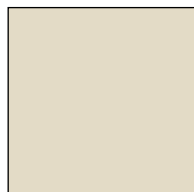

503-0 bianco assoluto

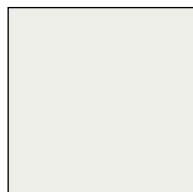

504-0 bianco caldo

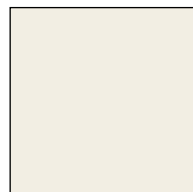

505-0 beige kenya



506-0 blu oltremare



507-0 caffè

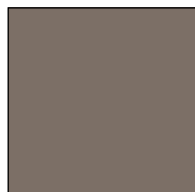

508-0 canapa



509-0 castoro

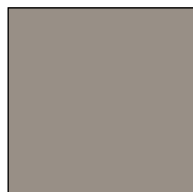

510-0 cenere

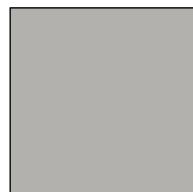

511-0 giallo ambrato

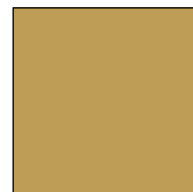

512-0 grigio bromo



513-0 grigio fumo

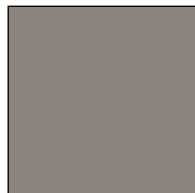

514-0 grigio piombo

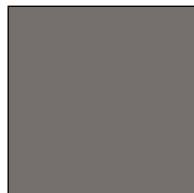

515-0 grigio seta

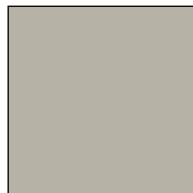

516-0 nero intenso



517-0 rosa quarzo

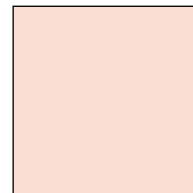

518-0 rosso

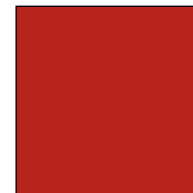

519-0 rosso toscano



520-0 rubino



521-0 tortora

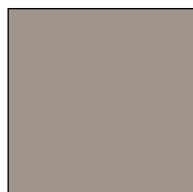

522-0 verde lichene



523-0 verde positano

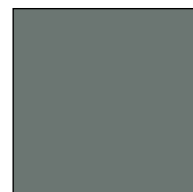

524-0 verde provenza

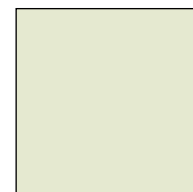

verniciatura
ecologica

La vernice ecologica utilizzata, grazie all'alta percentuale di acqua all'interno della propria composizione, ha un impatto decisamente meno nocivo sull'ambiente.

Die verwendete ökologische Farbe hat dank des hohen Wasseranteils in ihrer Zusammensetzung eine wesentlich geringere Umweltbelastung.

Colore RAL o NCS a scelta con sovrapprezzo
Colore a campione con sovrapprezzo
Consegna 5 settimane

*Farbe RAL oder NCS wahlweise mit Aufpreis
Farbe nach Muster mit Aufpreis
Lieferzeit 5 Wochen*



LUX

ACRILICO LUCIDO

ACRYLBESCHICHTUNG AUSFÜHRUNG GLÄNZEND

Pannello in agglomerato di particelle di legno spessore 22 mm, rivestito fronte e retro in acrilico atossico spessore 14/10, nelle tonalità previste, bordato in acrilico atossico spessore 1 mm, finito con raggio 1 mm. L'incollaggio della superficie e dei bordi viene effettuato con colle poliuretatiche termofondenti, resistenti all'umidità ed alla temperatura.

Holzspanplatte Stärke 22 mm, mit ungiftiger Acrylbeschichtung Stärke 14/10 auf zwei Seiten in den angebotenen Farben, ungiftige Acrylkante der Stärke 1 mm mit 1 mm Radius. Die Kanten werden mit Polyurethan-Schmelzklebern aufgeleimt, die feuchtigkeits und temperaturbeständig sind.

GRUPPO PREZZI / PREISGRUPPE

3

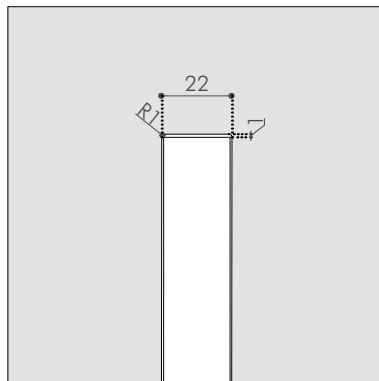

COLORI FRONTALI finitura lucida

FRONTFARBEN Hochglanz Ausführung

609 bianco puro

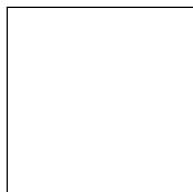

623 tortora

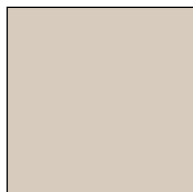

631 verde oliva

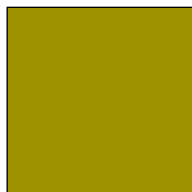

634 melanzana



674 caffè



683 cappuccino

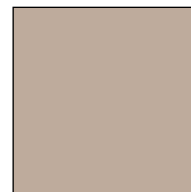

690 bianco

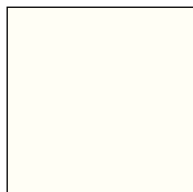

691 beige

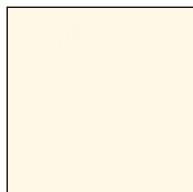

692 rosso



694 argilla



695 grigio singapore



Colori speciali a richiesta con sovrapprezzo

Sonderfarben auf Anfrage mit Aufpreis



LUX

ACRILICO OPACO

ACRYLBESCHICHTUNG AUSFÜHRUNG MATT

Pannello in agglomerato di particelle di legno spessore 22 mm rivestito fronte e retro in acrilico atossico, spessore 14/10, nelle tonalità previste, bordato in acrilico atossico spessore 1 mm, finito con raggio 1 mm. L'incollaggio della superficie e dei bordi viene effettuato con colle poliuretatiche termofondenti, resistenti all'umidità ed alla temperatura.

Holzspanplatte Stärke 22 mm, mit ungiftiger Acrylbeschichtung Stärke 14/10 auf zwei Seiten in den angebotenen Farben, ungiftige Acrylkante der Stärke 1 mm mit 1 mm Radius. Die Kanten werden mit Polyurethan-Schmelzklebern aufgeleimt, die feuchtigkeits und temperaturbeständig sind.

GRUPPO PREZZI / PREISGRUPPE

3

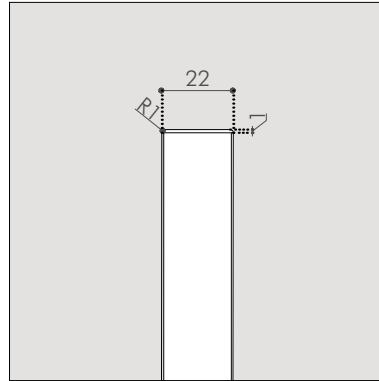

COLORI FRONTALI finitura opaca

FRONTFARBEN matt Ausführung

709 bianco puro

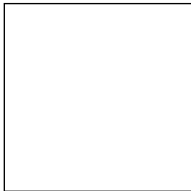

723 tortora

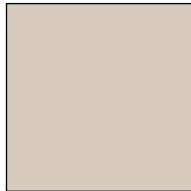

737 visone

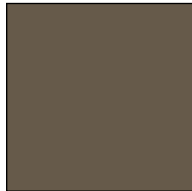

738 grigio sasso

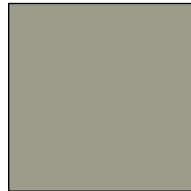

790 bianco

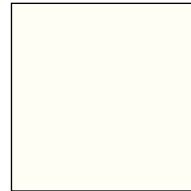

791 beige

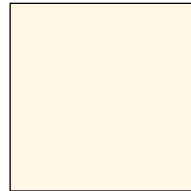

794 argilla



796 piombo

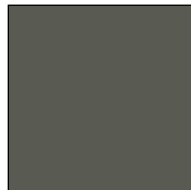

797 cenere

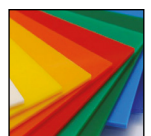

Pannello in agglomerato di particelle di legno spessore 21mm, rivestito in laminato Fenix NTM spessore 0,9 mm, ottenuto con l'ausilio della nanotecnologia, bordato in ABS spessore 1mm, finito con raggio 1 mm. L'incollaggio dei bordi è effettuato con colle poliuretatiche termofondenti, resistenti all'umidità ed alla temperatura.

Holzspanplatte Stärke 21 mm, mit 0,9 mm Fenix NTM Laminat beschichtet, das mit Nanotechnologie erzeugt wird, Kanten aus ABS der Stärke 1 mm mit 1 mm Radius. Die Kanten werden mit Polyurethan-Schmelzklebern aufgeleimt, die feuchtigkeits und temperaturbeständig sind.

GRUPPO PREZZI / PREISGRUPPE

4

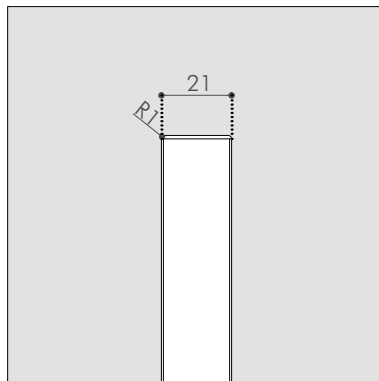
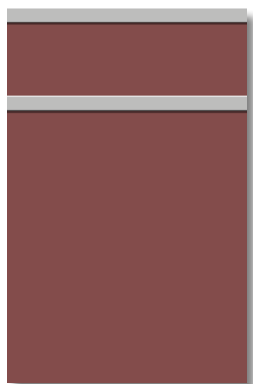

COLORI FRONTALI

FRONTFARBEN

800 bianco dover

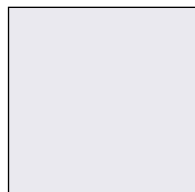

802 bianco kos

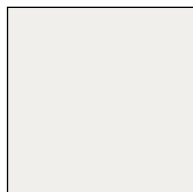

803 beige luxor

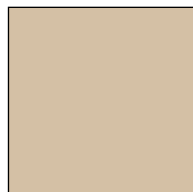

804 castoro ottawa

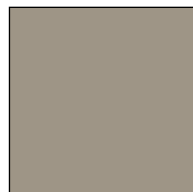

805 nero ingo



806 grigio bromo



807 grigio efeso

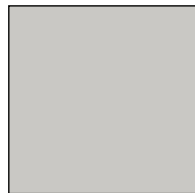

808 grigio londra

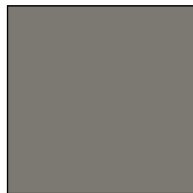

809 bianco malè

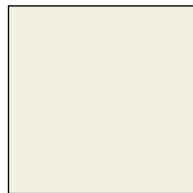

810 beige arizona

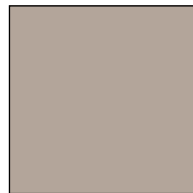

811 cacao orinoco



812 grigio antrim



813 verde comodoro



814 rosso jaipur

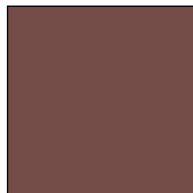

815 blu fes

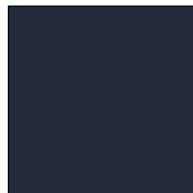

816 zinco doha



817 titanio doha



818 bronzo doha



819 piombo doha



QUADRA**LAMINATO HPL**
LAMINAT HPL

Pannello in multistrato fenolico di betulla finlandese spessore 20 mm, placcato fronte e retro in laminato HPL spessore 0,9 mm, nelle tonalità previste, raggio 5 mm sugli angoli e smusso perimetrale a 45°.

Platte aus Phenol-Birkensperrholz 20 mm dickem, Vorder- und Rückseite mit 0,9 mm dickem HPL-Laminat in den angegebenen Farben beschichtet, 5 mm Radius an den Ecken und 45° Umfangsfasse.

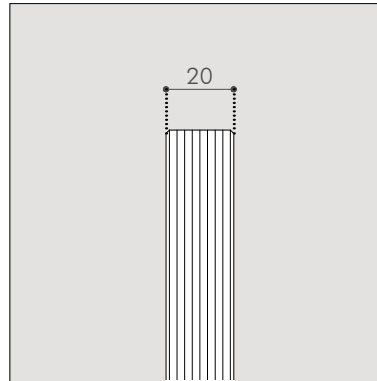
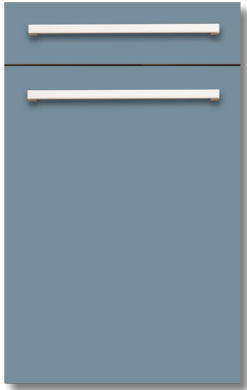
GRUPPO PREZZI / PREISGRUPPE**4****COLORI FRONTALI**
FRONTFARBEN

A410 bianco ghiaccio

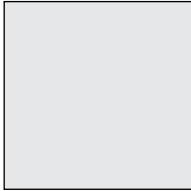

A831 rosso mattone

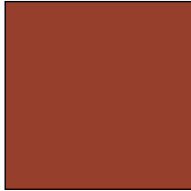

A1940 india

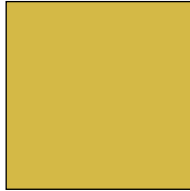

A1941 cadaques

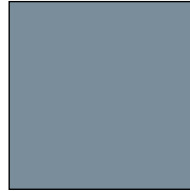

A1942 tuareg



A1943 tenebre



A1944 squalo

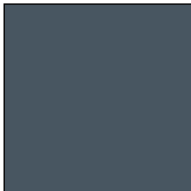

A1945 gange

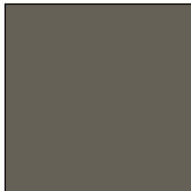

A146 orage



A1947 agave

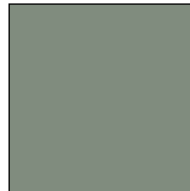

Colori speciali a richiesta con sovrapprezzo
Consegna 5 settimane

Sonderfarben auf Anfrage mit Aufpreis
Lieferzeit 5 Wochen



MIRADA A

LEGGNO oppure LEGNO LACCATO
HOLZ oder LACKIERT HOLZ

Pannello in agglomerato di particelle di legno spessore 21 mm, impiallacciato nelle varie essenze previste e bordato in legno spessore 1 mm, finito con raggio 1 mm su tutti i lati. L'incollaggio dei bordi è effettuato con colle poliuretaniche termofondenti, resistenti all'umidità ed alla temperatura. Verniciatura ecologica opaca a base acqua (versione legno) oppure laccatura ecologica a base acqua con venatura del legno a vista (versione legno laccato).

Holzspanplatte Stärke 21 mm, in den angebotenen Holzarten furniert, mit Holzkante der Stärke 1 mm und 1 mm Radius an allen Seiten. Die Kanten werden mit Polyurethan-Schmelzklebern aufgeleimt, die feuchtigkeits- und temperaturbeständig sind. Umweltfreundliche matte Lackierung auf Wasserbasis (Holz Ausführung) oder Umweltfreundliche Lackierung auf Wasserbasis mit sichtbarer Maserung (Holz lackiert Ausführung).

GRUPPO PREZZI / PREISGRUPPE

4

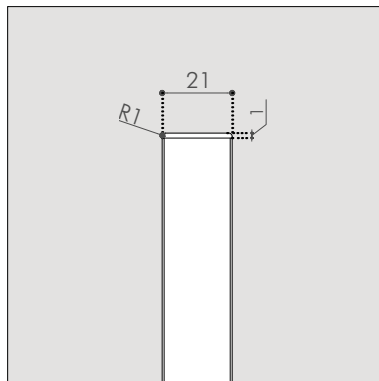
Mirada legno
Mirada HolzMirada laccata
Mirada lackiertCOLORI FRONTALI LEGNO
HOLZ FRONTFARBEN

462T rovere naturale



464T rovere tabacco

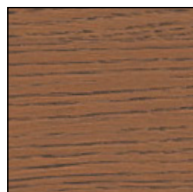

466T rovere grigio granito



467T rovere ostrica



462V rovere naturale

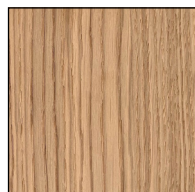

464V rovere tabacco

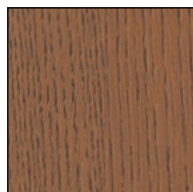

466V rovere grigio granito



467V rovere ostrica

COLORI FRONTALI LEGNO LACCATO SPAZZOLATO
FRONTALFARBEN LACKIERTES HOLZ GEBÜRSTET

es. 503T bianco assoluto

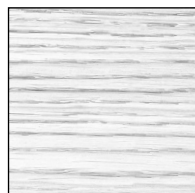

Per colori disponibili vedere laccati a pag. 65.
Codici colori da 501 (T oppure V a seconda della vena) a 524 (T oppure V).

*Verfügbare Farben siehe Lackierung auf Seite 65.
Farbcodes von 501 (T oder V je nach Vene) bis 524 (T oder V).*

Colore RAL o NCS a scelta con sovrapprezzo
Colore a campione con sovrapprezzo
Consegna 5 settimane

*Farbe RAL oder NCS wahlweise mit Aufpreis
Farbe nach Muster mit Aufpreis
Lieferzeit 5 Wochen*

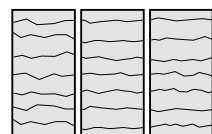

max 278 cm

Nella versione legno possibilità di continuità venatura orizzontale su blocchi omogenei (L MAX 278 cm) con sovrapprezzo

In der Holzversion Möglichkeit der horizontalen Maserungskontinuität auf homogenen Blöcken (L MAX 278 cm) mit Aufpreis

La vernice ecologica utilizzata, grazie all'alta percentuale di acqua all'interno della propria composizione, ha un impatto decisamente meno nocivo sull'ambiente.

Die verwendete ökologische Farbe hat dank des hohen Wasseranteils in ihrer Zusammensetzung eine wesentlich geringere Umweltbelastung.

verniciatura
ecologica

MIRADA B

LEGNO
HOLZ

Pannello in agglomerato di particelle di legno spessore 21/22 mm, impiallacciato nelle varie essenze previste e bordato in legno spessore 1 mm, finito con raggio 1 mm su tutti i lati. L'incollaggio dei bordi è effettuato con colle poliuretatiche termofondenti, resistenti all'umidità ed alla temperatura. Verniciatura ecologica opaca a base acqua.

Holzspanplatte Stärke 21/22 mm, in den angebotenen Holzarten furniert, mit Holzkante der Stärke 1 mm und 1 mm Radius an allen Seiten. Die Kanten werden mit Polyurethan-Schmelzklebern aufgeleimt, die feuchtigkeits- und temperaturbeständig sind. Ökologische Mattfarbe auf Wasserbasis.

GRUPPO PREZZI / PREISGRUPPE

5

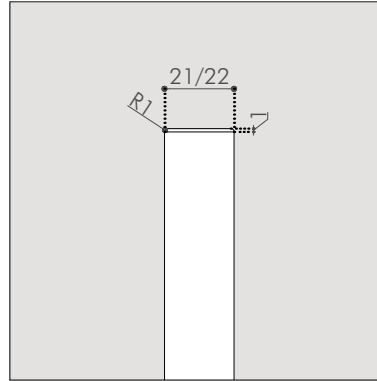
COLORI FRONTALI
FRONTFARBEN

401V cirmolo



402V olmo



403V noce canaletto



411V larice nodi evaporato



412V larice nodi affumicato chiaro



413V larice nodi affumicato scuro



456V rovere antico



474V rovere termocotto

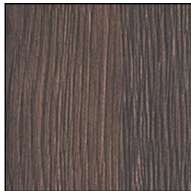

477V rovere nodi sigaro



479V rovere nodi montagna



La vernice ecologica utilizzata, grazie all'alta percentuale di acqua all'interno della propria composizione, ha un impatto decisamente meno nocivo sull'ambiente.

Die verwendete ökologische Farbe hat dank des hohen Wasseranteils in ihrer Zusammensetzung eine wesentlich geringere Umweltbelastung.



verniciatura
ecologica

ANTE TELAIO VETRO

LEGNO / LAMINATO
ALLUMINIO SENZA MANIGLIA
RAHMENTÜREN MIT GLAS
HOLZ/LAMINAT
ALUMINIUM OHNE GRIFF

GRUPPO PREZZI / PREISGRUPPE

5



TELAIO
legno/laminato 90 mm
in finitura frontali

*RAHMEN
aus Holz/Laminat 90 mm
in der Ausführung der
Fronten*



OREGON
telaio alluminio 60x22 mm
finitura titanio

*OREGON
Aluminiumrahmen 60x22 mm
Ausführung Titanium*

senza maniglia
ohne Griff



NEVADA
telaio alluminio 26x22 mm
finitura nera e titanio

*NEVADA
Aluminiumrahmen 26X22 mm
Ausführung schwarz
und Titanium*

senza maniglia
ohne Griff

VETRI GLÄSER

100 trasparente

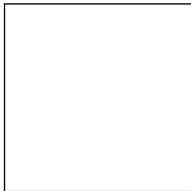

104 acidato interno

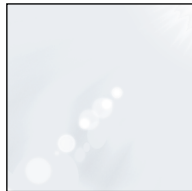

105 bronzo satinato

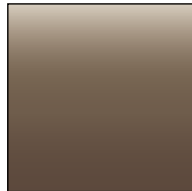

106 grigio satinato

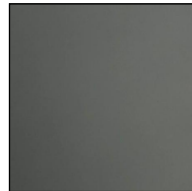

VETRI LACCATI LACKIERTE GLÄSER

es. 520 rubino

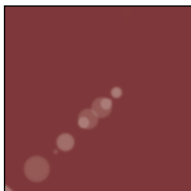

Con sovrapprezzo per vetro.
Per colori disponibili vedere laccati a pag. 65.
Codici colori da 501 a 524.

*Mit Aufpreis je Glas.
Verfügbare Farben siehe lackiert auf Seite 65.
Farbcodes von 501 bis 524.*

Nota: la laccatura, disponibile sia per vetri trasparenti che per vetri acidati, viene effettuata sempre sul lato interno.
Pertanto si ottiene l'effetto lucido esterno/laccato interno nel caso di vetri trasparenti oppure acidato esterno/laccato interno nel caso di vetri acidati.

*Hinweis: die Lackierung, die sowohl für transparentes als auch für säuregeätztes Glas erhältlich ist, erfolgt immer auf der Innenseite.
Daher wird der äußere/lackierte Innenglanzeffekt bei transparentem Glas bzw. der äußere/lackierte Innenglanzeffekt bei säuregeätztem Glas erzielt.*

Colore RAL o NCS a scelta con sovrapprezzo
Colore a campione con sovrapprezzo
Consegna 5 settimane
Farbe RAL oder NCS wahlweise mit Aufpreis
Farbe nach Muster mit Aufpreis
Lieferzeit 5 Wochen



BALI B

LACCATO LUCIDO
GLÄNZEND LACKIERT

Pannello in MDF spessore 22 mm, spigoli con raggio 2 mm.
Laccatura lucida con vernice poliaccrilica alto solido.

*Holzspanplatte Stärke 21/22 mm, Kanten mit 2 mm Radius.
Glänzende Lackierung mit hochfester Polyacrylfarbe.*

GRUPPO PREZZI / PREISGRUPPE

6



Maniglia PJJ
Griff PJJ

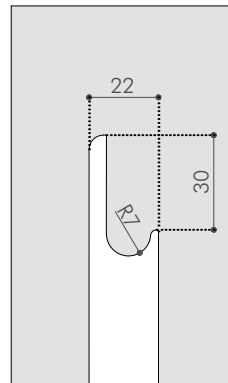
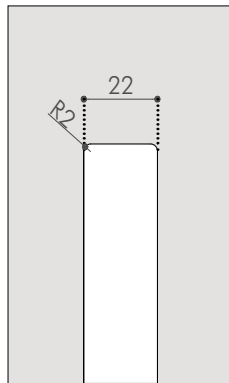

Maniglia PJJ
Griff PJJ

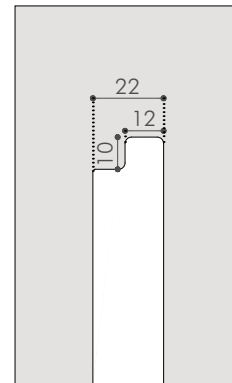

Maniglia LJ
Griff LJ

COLORI FRONTALI finitura lucida
FRONTFARBEN Hochglanz Ausführung

501-L argilla

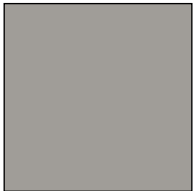

502-L avorio

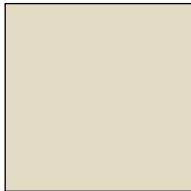

503-L bianco assoluto



504-L bianco caldo

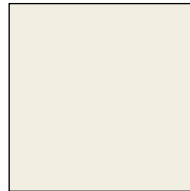

505-L beige kenya

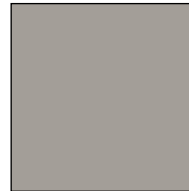

506-L blu oltremare



507-L caffè

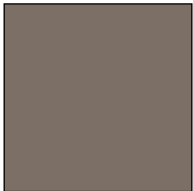

508-L canapa



509-L castoro

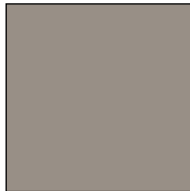

510-L cenere

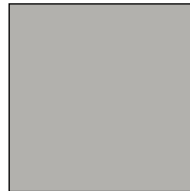

511-L giallo ambrato

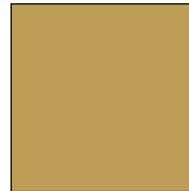

512-L grigio bromo

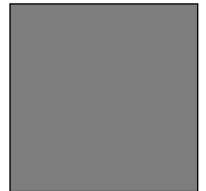

513-L grigio fumo

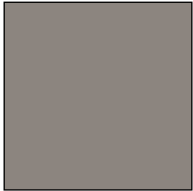

514-L grigio piombo

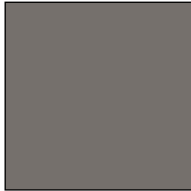

515-L grigio seta

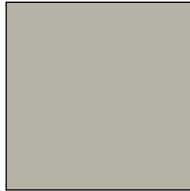

516-L nero intenso

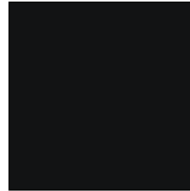

517-L rosa quarzo

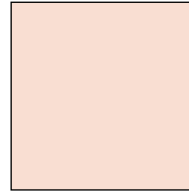

518-L rosso

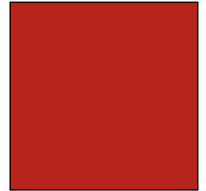

519-L rosso toscano

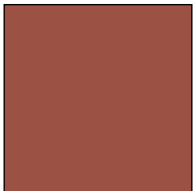

520-L rubino

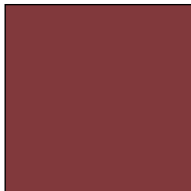

521-L tortora

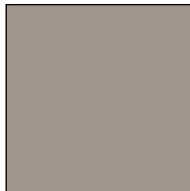

522-L verde lichene

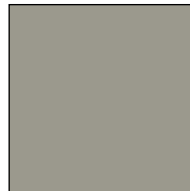

523-L verde positano

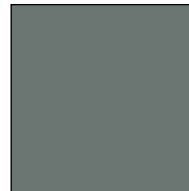

524-L verde provenza

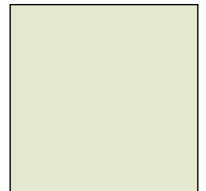

Tempo di consegna: 6 settimane
Lieferzeit: 6 Wochen

Colore RAL o NCS a scelta con sovrapprezzo
Colore a campione con sovrapprezzo

*Farbe RAL oder NCS wahlweise mit Aufpreis
Farbe nach Muster mit Aufpreis
Lieferzeit 5 Wochen*



Pannello in MDF spessore 22 mm, spigoli con raggio 2 mm.
Laccatura con vernice acrilica seguita da applicazione effetto pettro oppure
effetto striato.

MDF Holzplatte Stärke 22 mm, Kanten mit 2 mm Radius.
Lackierung mit Acrylfarbe mit anschließendem Zinn- oder Streifeneffekt.



Maniglia PJL
Griff PJL

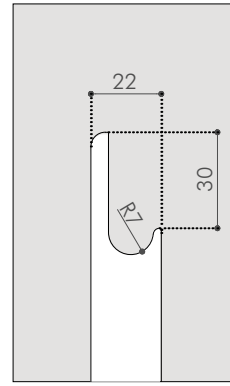
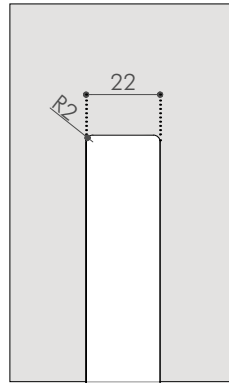

Maniglia PJL
Griff PJL

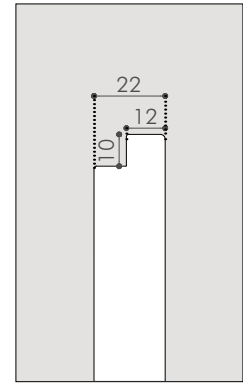

Maniglia LJ
Griff LJ

COLORI FRONTALI EFFETTO PELTRO
ZINNEFFEKT FRONTFARBEN

551 bronzo

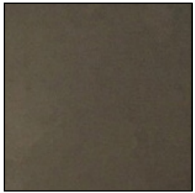

552 ferro



553 ottone



554 rame



555 petro scuro

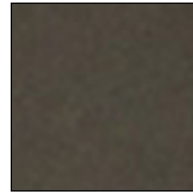

COLORI FRONTALI EFFETTO SATIN
SATINEFFEKT FRONTFARBEN

*effetto satin non compatibile con maniglia PJL ed LJ

*Satineffekt nicht erhältlich für PJL und LJ Griff

561 oro



562 metropolis



563 stagno

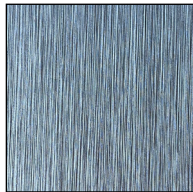

564 rame

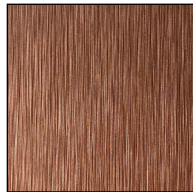

565 bronzo



Pannello in MDF spessore 22 mm, spigoli con raggio 2 mm.
Stuccatura manuale con successiva laccatura con vernice poliuretanica.

*MDF Holzspanplatte Stärke 21/22 mm, Kanten mit 2 mm Radius.
Manuelles Verpressen mit anschließender Lackierung mit Polyurethanlack.*

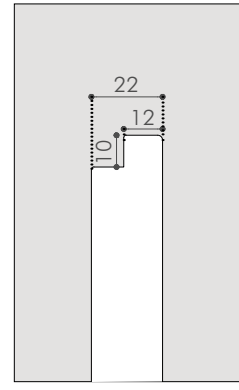
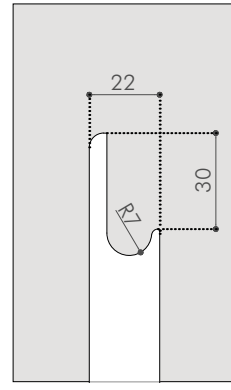
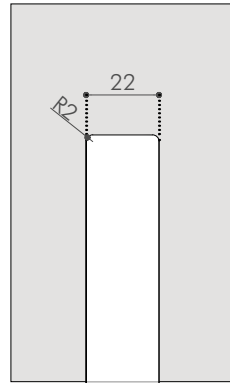
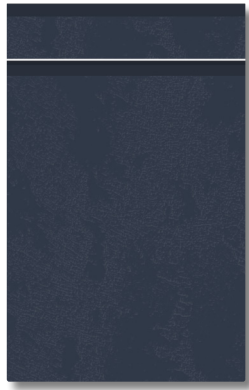
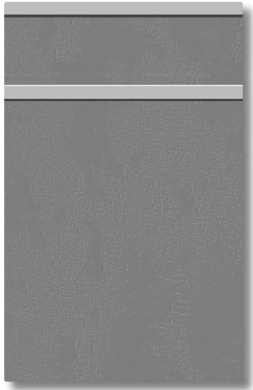

Maniglia PJJ
Griff PJJ

Maniglia PJJ
Griff PJJ

Maniglia LJ
Griff LJ

COLORI FRONTALI EFFETTO MATERICO
MATERIAEFFEKT FRONTFARBEN

501-M argilla



502-M avorio



503-M bianco assoluto

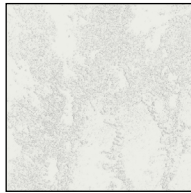

504-M bianco caldo



505-M beige kenya



506-M blu oltremare

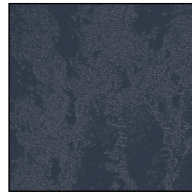

507-M caffè



508-M canapa



509-M castoro

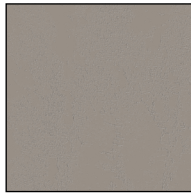

510-M cenere



511-M giallo ambrato

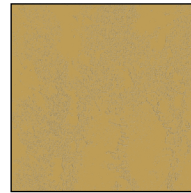

512-M grigio bromo

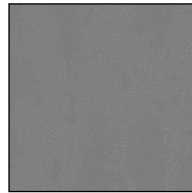

513-M grigio fumo



514-M grigio piombo

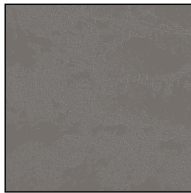

515-M grigio seta



516-M nero intenso

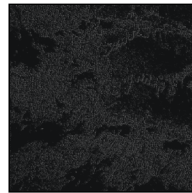

517-M rosa quarzo

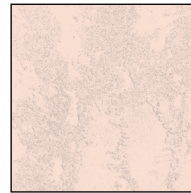

518-M rosso

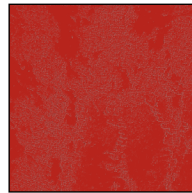

519-M rosso toscano

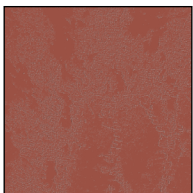

520-M rubino

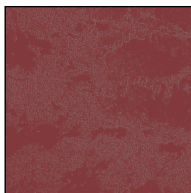

521-M tortora



522-M verde lichene



523-M verde positano



524-M verde provenza

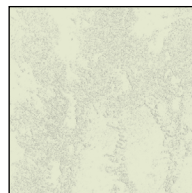

Tempo di consegna: 6 settimane
Lieferzeit: 6 Wochen

Colore RAL o NCS a scelta con sovrapprezzo
Colore a campione con sovrapprezzo

Farbe RAL oder NCS wahlweise mit Aufpreis
Farbe nach Muster mit Aufpreis
Lieferzeit 5 Wochen



Pannello in agglomerato di particelle di legno spessore 17,5 mm, impiallacciato nelle varie essenze previste, bordato su 4 lati con massello di legno sp. 22 mm, raggiato 2 mm su tutti gli spigoli. Verniciatura acrilica opaca (versione legno) oppure laccatura acrilica con venatura del legno a vista (versione legno laccato).

Holzspanplatte Stärke 17 mm, in den angebotenen Holzarten furniert, mit Massivholz der Stärke 22 mm an vier Seiten eingefasst, an allen Kanten 2 mm gerundet. Matte Acryl Lackierung (Holz Ausführung) oder Acryl Lackierung mit sichtbarer Maserung (Holz lackiert Ausführung).

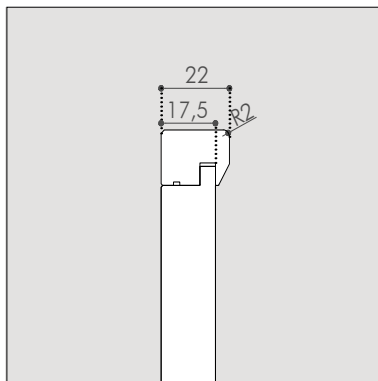
Kron legno
Kron HolzKron laccata
Kron lackiert

COLORI FRONTALI LEGNO

HOLZ FRONTFARBEN

402V olmo



403V noce canaletto

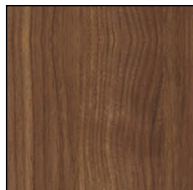

477V rovere nodi sigaro

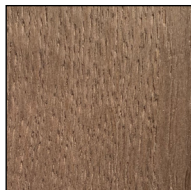

479V rovere nodi montagna



COLORI FRONTALI LEGNO LACCATO SPAZZOLATO

FRONTALFARBEN LACKIERTES HOLZ GEBÜRSTET

es. 503V bianco assoluto

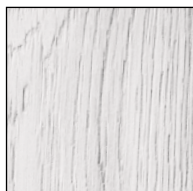

Per colori disponibili vedere laccati a pag. 65.
Codici colori da 501V a 524V.

*Verfügbare Farben siehe Lackierung auf Seite 65.
Farbcodes von 501V bis 524V.*

Colore RAL o NCS a scelta con sovrapprezzo
Colore a campione con sovrapprezzo

*Farbe RAL oder NCS wahlweise mit Aufpreis
Farbe nach Muster mit Aufpreis*



Pannello in agglomerato di particelle di legno spessore 20 mm, in finitura melaminica grigia rivestita con foglio inox AISI 304 finitura scotch-brite, con angolini di finitura arrotondati raggio 2 mm.

Holzspanplatte, Stärke 20 mm, mit grauer Melaminbeschichtung, die mit einem Edelstahlblech AISI304 beschichtet ist, mit Scotch-Brite-Satinierung, Ecken mit 2 mm Radius.

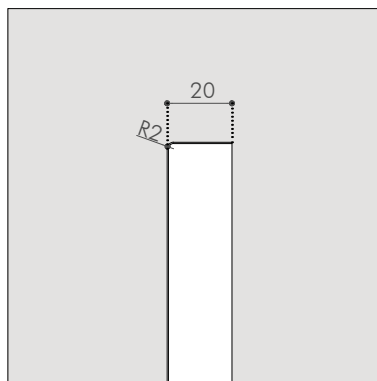
GRUPPO PREZZI / PREISGRUPPE**6****COLORI FRONTALI**
FRONTFARBEN

201 inox

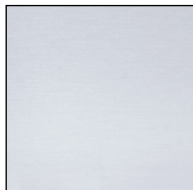

PRISMA VETRO**VETRO COLORATO**
FARBIGES GLAS

Pannello in MDF spessore 16 mm, bordato in ABS spessore 0,5 mm, spigoli con raggio 0,5 mm. Laccatura ecologica opaca a base acqua. Vetro lucido o satinato, colorato, spessore 4mm, accoppiato al pannello in MDF. Maniglia a profilo in alluminio integrata. Spessore totale antina 20 mm.

MDF-Platte Stärke 16 mm, ABS-Kante der Stärke 0,5 mm, Kanten mit 0,5 mm Radius. Umweltfreundliche matte Lackierung auf Wasserbasis. Glänzendes oder satiniertes farbiges Glas, Stärke 4 mm, kaschiert mit MDF-Platte. Integriertes Griffprofil aus Aluminium. Gesamtstärke der Tür 20 mm.

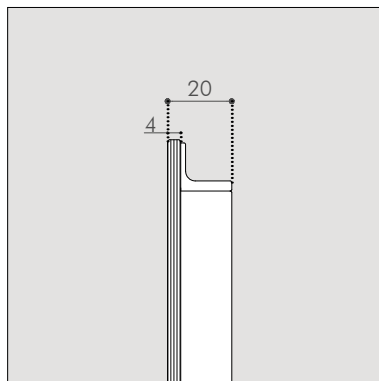
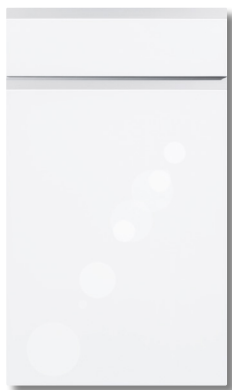
GRUPPO PREZZI / PREISGRUPPE**6****COLORI FRONTALI finitura satinata opaca***FRONTFARBEN satiniert matt Ausführung*

191 ghiaccio satinato



194 seta satinato



195 bronzo satinato

**COLORI FRONTALI finitura lucida***FRONTFARBEN Ausführung Hochglanz*

192 ghiaccio lucido



193 nero lucido

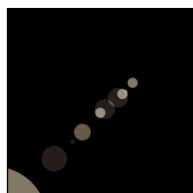

La vernice ecologica utilizzata, grazie all'alta percentuale di acqua all'interno della propria composizione, ha un impatto decisamente meno nocivo sull'ambiente.

Die verwendete ökologische Farbe hat dank des hohen Wasseranteils in ihrer Zusammensetzung eine wesentlich geringere Umweltbelastung.



verniciatura
ecologica

Pannello in MDF spessore 16 mm, bordato in ABS spessore 0,5 mm, spigoli con raggio 0,5 mm. Laccatura ecologica opaca a base acqua. Ceramica Laminam spessore 6 mm, accoppiata al pannello in MDF. Maniglia a profilo in alluminio integrata. Spessore totale antina 22 mm.

MDF-Platte Stärke 16 mm, ABS-Kante der Stärke 0,5 mm, Kanten mit 0,5 mm Radius. Umweltfreundliche matte Lackierung auf Wasserbasis. Keramik Laminam, Stärke 6 mm, kaschiert mit MDF-Platte. Integriertes Griffprofil aus Aluminium. Gesamtstärke der Tür 22 mm.

GRUPPO PREZZI / PREISGRUPPE

7

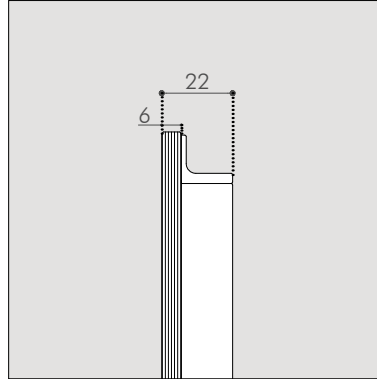

COLORI FRONTALI

FRONTFARBEN

173 fokos terra

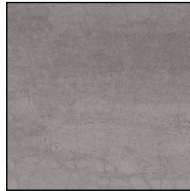
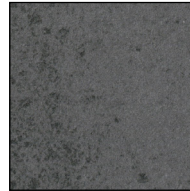
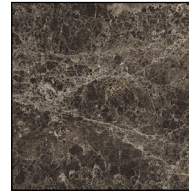

174 fokos roccia

179 pietra di
savoia grigia180 pietra di
savoia antracite181 emperador
extra opaco

182 noir desir opaco

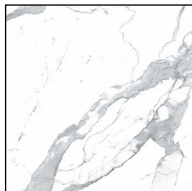
183 calacatta oro
venato lucidato184 bianco statuario
venato lucidato

186 calce bianco



187 calce grigio



188 calce nero



La vernice ecologica utilizzata, grazie all'alta percentuale di acqua all'interno della propria composizione, ha un impatto decisamente meno nocivo sull'ambiente.

Die verwendete ökologische Farbe hat dank des hohen Wasseranteils in ihrer Zusammensetzung eine wesentlich geringere Umweltbelastung.



verniciatura
ecologica

CAMPIGLIO

LEGGNO
HOLZ

Doghe verticali in pannello MDF sp. 20 e 23 mm alternate, impiallacciate nelle varie essenze previste, bordate su tutti i lati con raggio 1 mm su tutti gli spigoli. Maniglia fresata verticale continua o orizzontale centrata. Verniciatura acrilica opaca.

Vertikale Leisten in MDF Stärke 20 mm und 23 mm abwechselnd, in den angebotenen Holzarten furniert, an vier Seiten eingefasst, 1 mm an allen Seiten gerundet. Vertikaler und durchgehender eingeprägter Griff, oder horizontaler zentriert. Matte Acryl Lackierung.

GRUPPO PREZZI / PREISGRUPPE

7



Maniglia orizzontale
Horizontal Griff



Maniglia verticale
Vertikal Griff

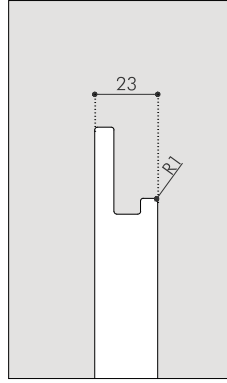

Maniglia orizzontale
Horizontal Griff

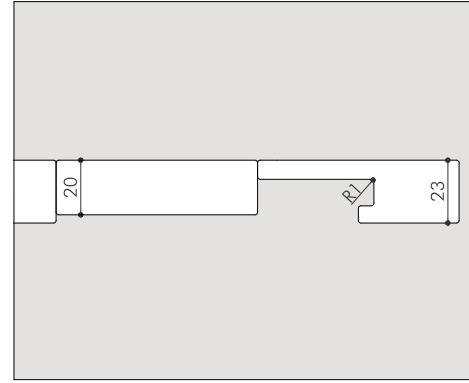

Maniglia verticale
Vertikal Griff

COLORI FRONTALI FRONTFARBEN

401V cirmolo



402V olmo

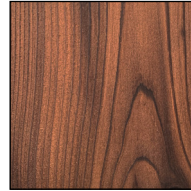

403V noce canaletto

411V larice nodi
evaporato412V larice nodi
affumicato chiaro413V larice nodi
affumicato scuro

477V rovere nodi sigaro



479V rovere nodi montagna



ARGILLA**ARGILLA**
TONMISCHUNG

Pannello in MDF spessore 22 mm, spigoli con raggio 2 mm. Lavorazione esclusivamente manuale: stesura in due mani, ciascuna seguita da carteggiatura, di impasto di argilla e verniciatura finale con trattamento superficiale acrilico antimacchia.

MDF-Platte Stärke 22 mm, Kanten mit 2 mm Radius. Verarbeitung ausschließlich von Hand: Auftragen in zwei Schichten, jeweils gefolgt von Schleifen der Tonmischung; abschließende Bemalung mit einer schmutzabweisenden Acryl-Oberflächenbehandlung.

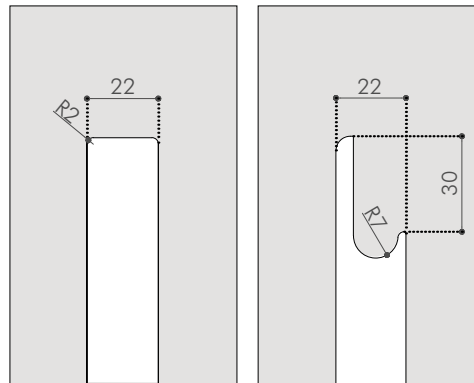
GRUPPO PREZZI / PREISGRUPPE**7**

Maniglia P.J.L.
Griff P.J.L.

COLORI FRONTALI
FRONTFARBEN

581 ardesia



582 lava



583 neve



584 pece



585 polvere



586 sabbia



587 tempesta



588 vinaccia

