

**TOPS**  
tipi di tops e tipologia incassi  
soluzioni sporgenze tops

**ARBEITSPLETTEN**  
Arten von Arbeitsplatten und Art der  
Einnahmen  
Arten von Überhängen

		standard standard	filo top flush with the worktop	sotto top under top
<b>Top laminato HPL</b> <i>HPL-Laminat Arbeitsplatten</i>				
<b>Top fullcolor</b> <i>Fullcolor Arbeitsplatten</i>				
<b>Top vetro</b> <i>Glas Arbeitsplatten</i>				
<b>Top acciaio</b> <i>Stahl Arbeitsplatten</i>				
<b>Top ceramica</b> <i>Keramik Arbeitsplatten</i>	 			

**Tipologia fori elettrodomestici**  
*Art der Löcher für Haushaltsgeräte*

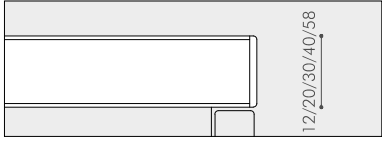
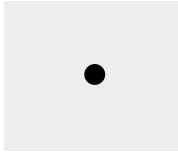
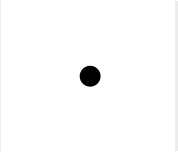
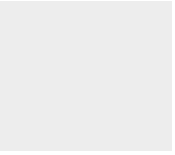
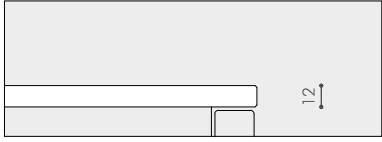
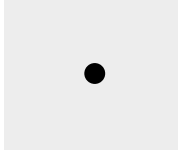
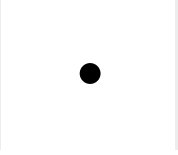
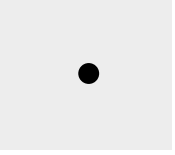
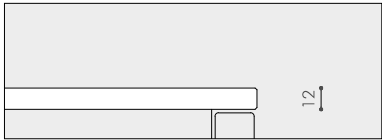
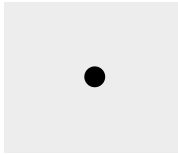
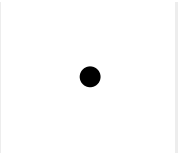
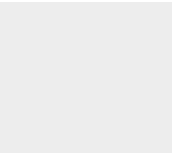
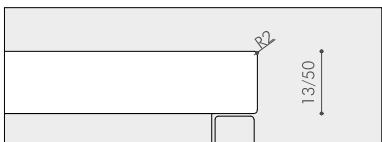
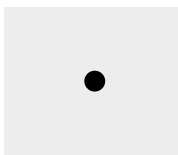
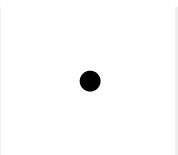
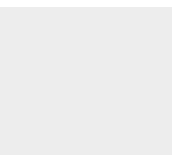
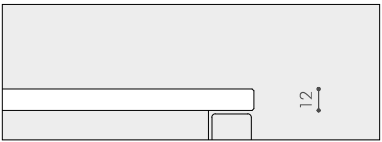
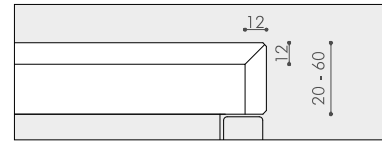
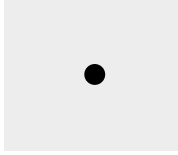
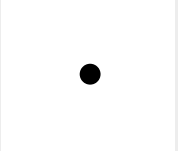
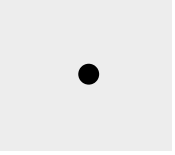
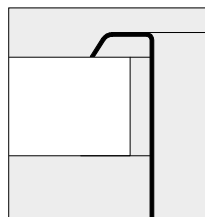

**Foro incasso standard**  
fornire scheda tecnica  
elettrodomestico  
**Standard-Vertiefungsbohrung**  
Datenblatt für Haushaltsgeräte  
bereitstellen

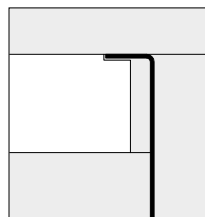

**Foro incasso filotop**  
fornire elettrodomestico da  
incassare  
**Bündig montierte Bohrung**  
Haushaltsgeräte zur  
Einlösung bereitstellen

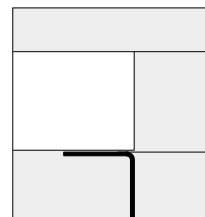

**Foro incasso sottotop**  
fornire elettrodomestico da  
incassare  
**Eingelassene Bohrung unter der Oberseite**  
Haushaltsgeräte zur Einlösung bereitstellen

**Opzioni montaggio top**  
*Montageoptionen der Arbeitsplatten*

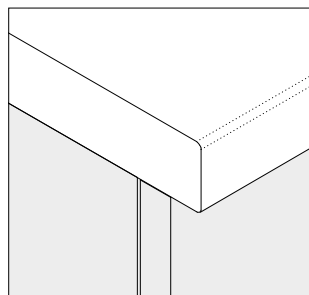

**Top sporgente**  
sporgenza 18-22 mm  
dall'anta  
**Vorstehender  
Arbeitsplatte**  
Ausladung 18-22 mm  
von der Tür aus

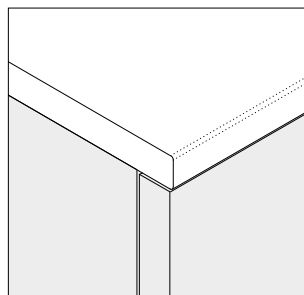

**Top a filo anta**  
sporgenza 2 mm  
dall'anta  
**Bündige Tür oben**  
Ausladung 2 mm  
von der Tür aus

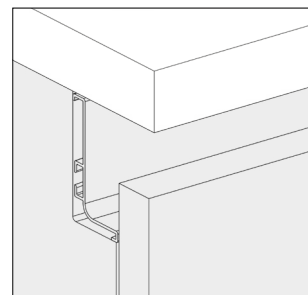

**Top a filo anta con gola**  
sporgenza 2 mm  
dall'anta  
**Bündige Tür oben mit  
Griffleiste**  
Ausladung 2 mm  
von der Tür aus

**TOPS LAMINATO HPL**

**MATERICI**

**HPL-LAMINAT ARBEITSPLETTEN**

**MATERIAL**

Pannello in agglomerato di particelle di legno spessore variabile, placcato in laminato HPL (un lato), bordato in ABS spessore 1,5 mm. L'incollaggio dei bordi è effettuato con colle poliuretaniche termofondenti, resistenti all'umidità ed alla temperatura.

Platte aus Holzspan-Agglomeratplatten mit variabler Dicke, einseitig mit HPL-Laminat beschichtet und mit 1,5 mm dickem ABS eingefasst. Die Kanten werden mit thermoschmelzenden, feuchtigkeits- und temperaturbeständigen Polyurethanklebern verleimt.

**TOPS LAMINATO HPL**

sp. 12/20/30/40/58 mm

realizzati a misura  
dimensioni max 4180 x 1280 mm

**HPL-LAMINAT ARBEITSPLETTEN**

12/20/30/40/58 mm dick

nach Maß  
max. Abmessungen 4180 x 1280 mm

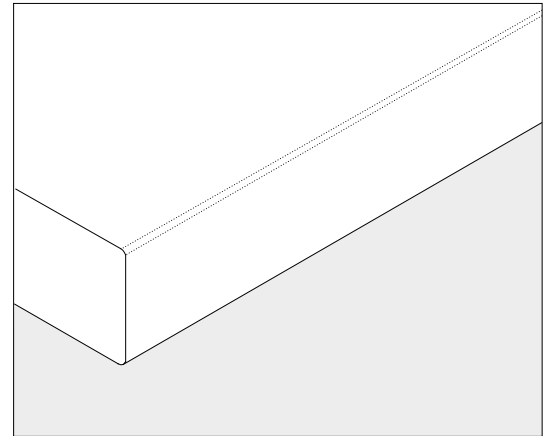
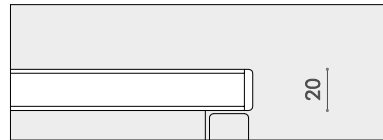
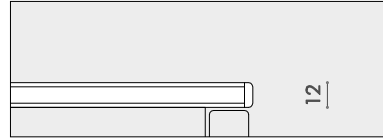

**COLORI TOPS HPL CEMENTO**  
**FARBEN ARBEITSPLETTEN HPL ZEMENT**

930 zement



931 cimant white



932 cimant ash



933 cimant grey



**COLORI TOPS HPL PIETRA**  
**FARBEN ARBEITSPLETTEN HPL STEIN**

964 pietra luna



965 pietra nera



966 pietra bianca



**COLORI TOPS HPL METALLO**  
**FARBEN ARBEITSPLETTEN HPL METAL**

934 bronze

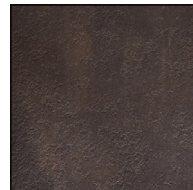

935 silver



**COLORI TOPS HPL MARMO**  
**FARBEN ARBEITSPLETTEN HPL MURMEL**

920 marmo statuario



921 marmo alicante

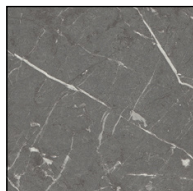

922 marmo marquinia

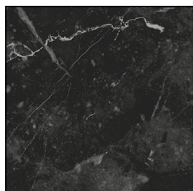

Tutti gli HPL materici sono caratterizzati da uno strato decorativo antibatterico che, unitamente all'impiego delle corrette pratiche di pulizia, è in grado di ridurre la carica batterica fino al 99,9% (test conformi alla ISO 22196).

Alle HPL-Materialien zeichnen sich durch eine dekorative antibakterielle Schicht aus, die zusammen mit der Anwendung der richtigen Reinigungspraktiken in der Lage ist, die bakterielle Belastung bis zu 99,9% zu reduzieren (Tests nach ISO 22196).

**PIANI SNACK, BANCONI E PIANI  
TAVOLO IN LAMINATO HPL**

**LEGNO**

**HPL LAMINAT-SNACKPLATTEN,  
THEKEN UND TISCHPLATTEN**

**HOLZ**

Pannello in agglomerato di particelle di legno spessore variabile, placcato fronte e retro in laminato HPL, bordato in ABS spessore 1 mm. L'incollaggio dei bordi è effettuato con colle poliuretaniche termofondenti, resistenti all'umidità ed alla temperatura.

Platte aus Holzspan-Agglomeratplatten mit variabler Dicke, Vorder- und Rückseite mit HPL-Laminat beschichtet, umrandet mit 1 mm dickem ABS. Die Kanten werden mit thermoschmelzenden, feuchtigkeits- und temperaturbeständigen Polyurethanklebern verleimt.

**PIANI LAMINATO HPL**

sp. 12/20/30/40/58 mm

realizzati a misura  
dimensioni max: 2780 x 1280 mm

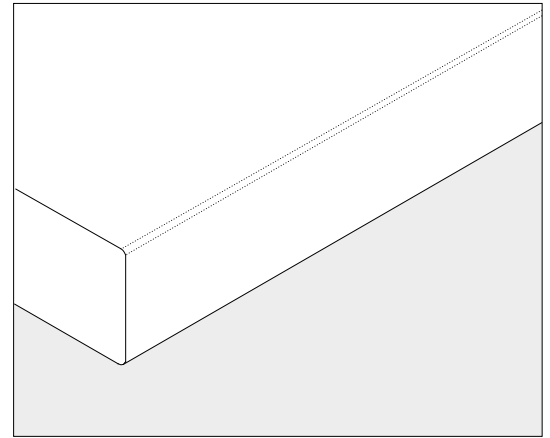
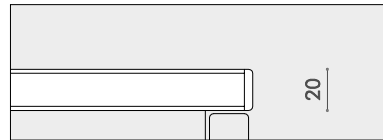
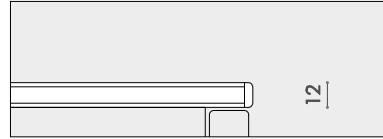

**HPL-LAMINAT PLATTEN**

12/20/30/40/58 mm dick

nach Maß  
max. Abmessungen 2780 x 1280 mm

**COLORI PIANI HPL LEGNO - 2780 x 1280 mm**

**FARBEN HPL PLATTEN HOLZ - 2780 x 1280 mm**

956 larice termotrattato



958 larice bruno



959 larice antracite



960 larice bianco



962 rovere halifax naturale



963 rovere halifax tabacco



981 rovere nodi naturale



982 olmo bruno



983 noce lincoln



Tutti gli HPL legno sono caratterizzati da elevate proprietà antibatteriche, ottenute grazie alla superficie a base di resina melaminica, senza l'aggiunta di additivi (test conformi alla ISO 22196). E' sufficiente una pulizia domestica regolare per mantenere tali proprietà invariate.

Alle HPL-Materialien zeichnen sich durch eine dekorative antibakterielle Schicht aus, die zusammen mit der Anwendung der richtigen Reinigungspraktiken in der Lage ist, die bakterielle Belastung bis zu 99,9% zu reduzieren (Tests nach ISO 22196).

**TOPS LAMINATO HPL**

**LAMINATO FENIX**

**HPL-LAMINAT ARBEITSPLATTEN**

**FENIX- LAMINAT**

Pannello in agglomerato di particelle di legno spessore variabile, rivestito in laminato Fenix NTM spessore 0,9 mm, ottenuto con l'ausilio della nanotecnologia, bordato in ABS spessore 1mm, finito con raggio 1 mm. L'incollaggio dei bordi è effettuato con colle poliuretatiche termofondenti, resistenti all'umidità ed alla temperatura.

Platte aus Holzspanplatten-Agglomerat mit variabler Dicke, bedeckt mit dem 0,9 mm dicken Laminat Fenix NTM, das mit Hilfe der Nanotechnologie hergestellt wurde, eingefasst in ABS mit einer Dicke von 1 mm und mit einem Radius von 1 mm verarbeitet. Die Kanten werden mit thermoschmelzenden, feuchtigkeits- und temperaturbeständigen Polyurethanklebern verleimt.

**TOPS LAMINATO HPL**

sp. 12/20/30/40/58

realizzati a misura  
dimensioni max 4180 x 1280 mm

**HPL-LAMINAT ARBEITSPLATTEN**

12/20/30/40/58 dick

nach Maß  
max. Abmessungen 4180 x 1280 mm

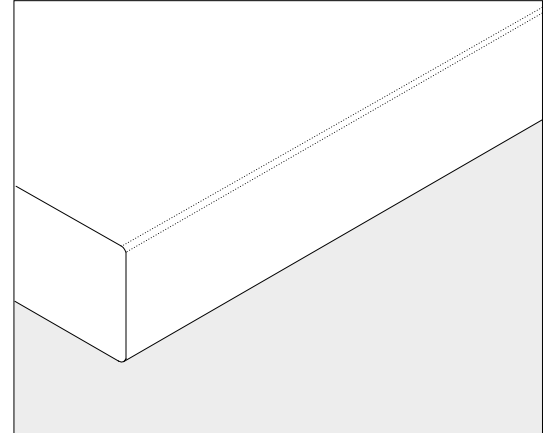
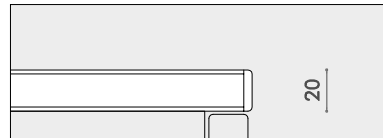

**COLORI TOPS**

**FARBEN ARBEITSPLATTEN**

800 bianco dover



802 bianco kos

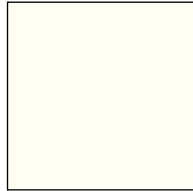

803 beige luxor



804 castoro ottawa

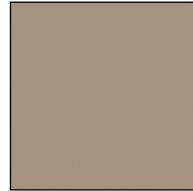

805 nero ingo



806 grigio bromo

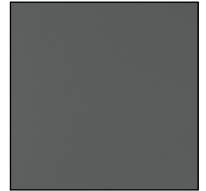

807 grigio efeso

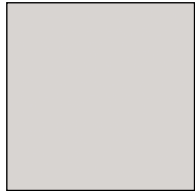

808 grigio londra

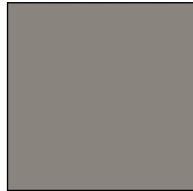

809 bianco malè

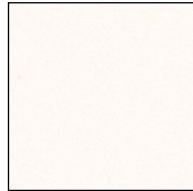

810 beige arizona

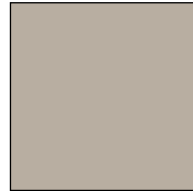

811 cacao orinoco



812 grigio antrim

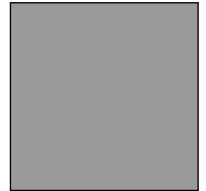

813 verde comodoro

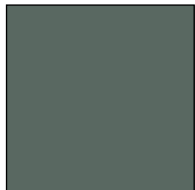

814 rosso jaipur

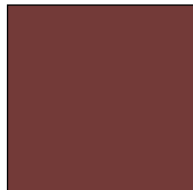

815 blu fes



816 zinco doha



817 titanio doha



818 bronzo doha



819 piombo doha

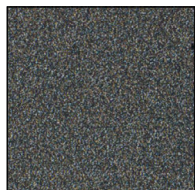

**TOPS FULLCOLOR**  
**FULLCOLOR ARBEITSPLATTE**

Materiale colorato in superficie e in tutto lo spessore di 12 mm con colori predefiniti, composto di fogli di carta impregnati di resina termoindurente e sottoposti all' azione combinata di calore e alta pressione.  
Bordi finiti con smusso 1 x 1 mm.

*Gefärbtes Material auf der Oberfläche und in der gesamten Dicke von 12 mm mit vordefinierten Farben, bestehend aus Papierblättern, die mit wärmehärtbarem Harz imprägniert und der kombinierten Einwirkung von Wärme und hohem Druck ausgesetzt sind.  
Fertige Kanten mit 1 x 1 mm Fase.*

**TOPS FULLCOLOR**

sp. 12 mm

realizzati a misura  
dimensioni max 4190 x 1590 mm**FULLCOLOR ARBEITSPLATTEN**

12 mm dick

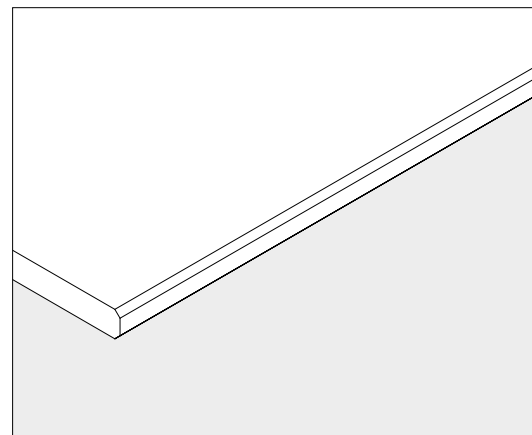
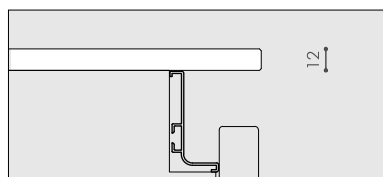
nach Maß  
max. Abmessungen 4190 x 1590 mm**COLORI TOPS**  
**FARBEN ARBEITSPLATTEN**

FC1 bianco ghiaccio

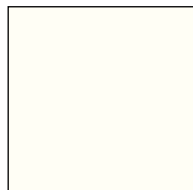

FC2 nero

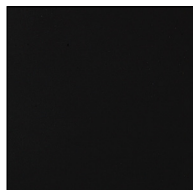

**TOPS VETRO LACCATO**  
**LACKIERT GLAS ARBEITSPLETTEN**

Lastra di vetro temperato spessore 12 mm, finitura satinata o lucida, con laccatura ecologica a base acqua su un lato. Bordi finiti con smussi 2 x 2 mm.

*Gehärtete Glasscheibe 12 mm dick, satiniert oder poliert, mit ökologischem Lack auf Wasserbasis auf einer Seite. Fertige Kanten mit 2 x 2 mm Fasen.*

**TOPS VETRO LACCATO**

sp. 12 mm

realizzati a misura  
dimensioni max 3200 x 1600 mm

**LACKIERT GLAS ARBEITSPLETTEN**

12 mm dick

nach Maß  
max. Abmessungen 3200 x 1600 mm

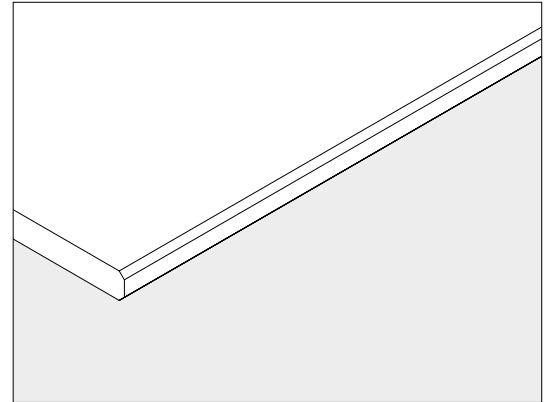
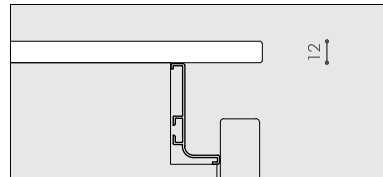
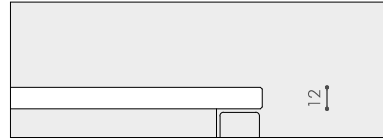

**COLORI TOPS**  
**FARBEN ARBEITSPLETTEN**

501 argilla



502 avorio

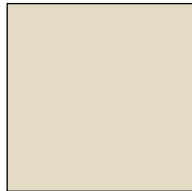

503 bianco assoluto



504 bianco caldo

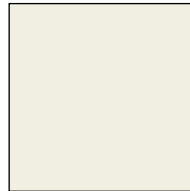

505 beige kenya

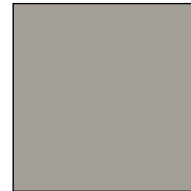

506 blu oltremare

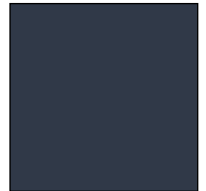

507 caffè



508 canapa



509 castoro

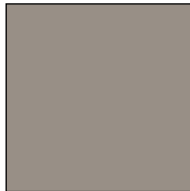

510 cenere

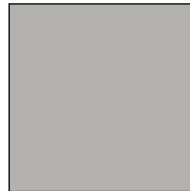

511 giallo ambrato

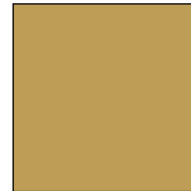

512 grigio bromo

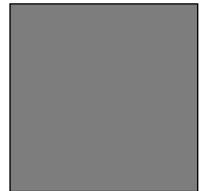

513 grigio fumo

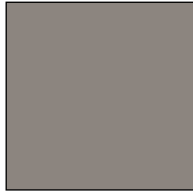

514 grigio piombo

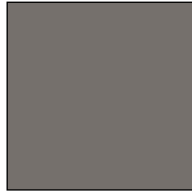

5150 grigio seta

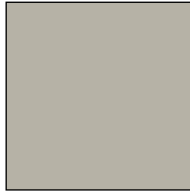

516 nero intenso

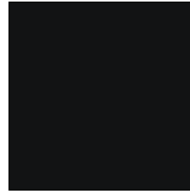

517 rosa quarzo

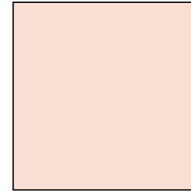

518 rosso

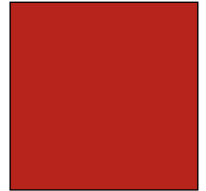

519 rosso toscano

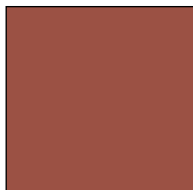

520 rubino



521 tortora

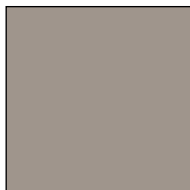

522 verde lichene

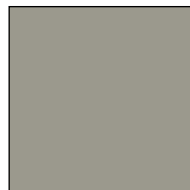

523 verde positano

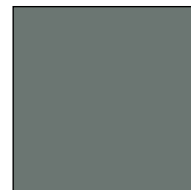

524 verde provenza

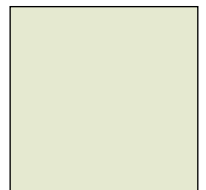

verniciatura  
ecologica

La vernice ecologica utilizzata, grazie all'alta percentuale di acqua all'interno della propria composizione, ha un impatto decisamente meno nocivo sull'ambiente.

*Die verwendete ökologische Farbe hat dank des hohen Wasseranteils in ihrer Zusammensetzung eine wesentlich geringere Umweltbelastung.*

Colore RAL o NCS a scelta con sovrapprezzo  
Colore a campione con sovrapprezzo  
Consegna 5 settimane

*RAL - oder NCS-Farbe mit Aufpreis  
Musterfarbe mit Aufpreis  
Lieferzeit 5 Wochen*



**TOPS ACCIAIO****STAHL ARBEITSPLETTEN**

Pannello in agglomerato di particelle di legno spessore variabile, con foglio acciaio INOX AISI 304 18/10 spessore minimo 1 mm, in finitura satinata. Bordi ripiegati e saldati sugli spigoli.

Platte aus Agglomerat-Holzspanplatten mit variabler Dicke, mit Edelstahlblech AISI 304 18/10, Mindestdicke 1 mm, in satinierter Ausführung. Kanten gefaltet und an den Kanten verschweißt.

**TOPS ACCIAIO**

sp. 13-50 mm

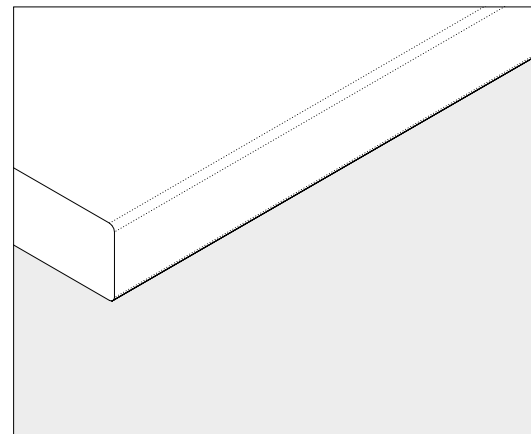
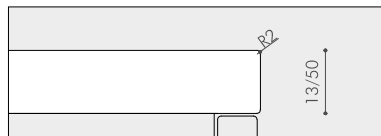
realizzati a misura  
dimensioni max 4300x1300 mm**STAHL ARBEITSPLETTEN**

13-50 mm dick

nach Maß

max. Abmessungen 4300 x 1300 mm

**COLORI TOPS****FARBEN ARBEITSPLETTEN**

scotch brite

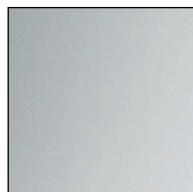

vissuto





**TOPS CERAMICA LAMINAM**

**KERAMIK ARBEITSPLETTEN**

Lastra piena in materiale ceramico, spessore 12 mm, resistente all' usura, idrorepellente, igienico, eco compatibile e resistente alle macchie.

Massivplatte aus keramischem Material, 12 mm dick, verschleißfest, wasserabweisend, hygienisch, umweltfreundlich und schmutzabweisend.

**TOPS CERAMICA LAMINAM**

sp. 12 mm

realizzati a misura  
dimensioni max 3240x1620 mm

**KERAMIK ARBEITSPLETTEN**

12 mm dick

nach Maß

max. Abmessungen 3240x1620 mm

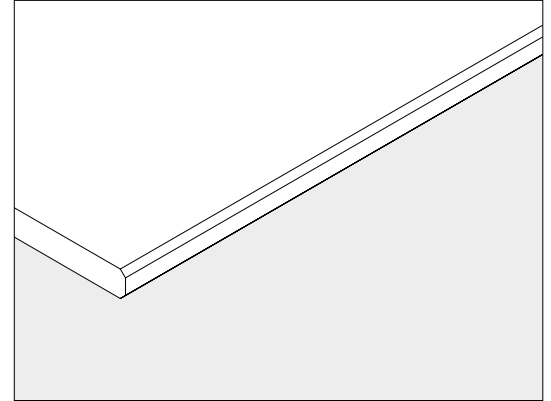
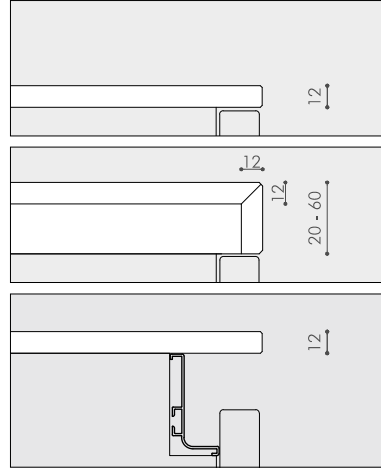

**COLORI TOPS**

**FARBEN ARBEITSPLETTEN**

173 fokus terra

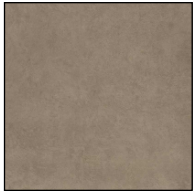

174 fokus roccia



179 pietra di savoia grigia

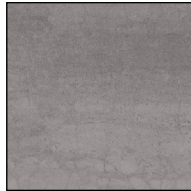

180 pietra di savoia antracite

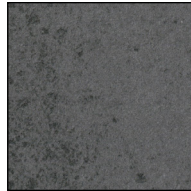

181 emperador extra opaco

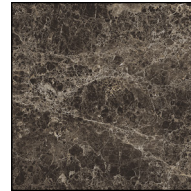

182 noir desir opaco

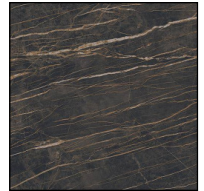

183 calacatta oro venato lucidato



184 bianco statuario venato lucidato

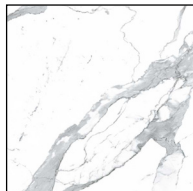

186 calce bianco



187 calce grigio



188 calce nero

